

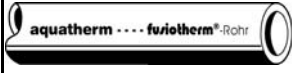

Kunde : _____
 Anlage : _____
 Projekt-Nr. _____

Lieferort : _____

Termin : _____
 Avis an: _____

		Menge [m]
Rohr		
70708	20 x 2,8 mm	
70710	25 x 3,5 mm	
70112	32 x 4,4 mm	
70114	40 x 5,5 mm	
70116	50 x 6,9 mm	
70118	63 x 8,6 mm	
70120	75 x 10,3 mm	
70122	90 x 12,3 mm	
70124	110 x 15,1 mm	
70126	125 x 17,1 mm	
70130	160 x 21,9 mm	
70134	200 x 27,4 mm	

	Rohrschelle M8 /M10	Menge [Stk]
60520	20 mm	
60525	25 mm	
60532	32 mm	
60540	40 mm	
60550	50 mm	
60563	63 mm	
60575	75 mm	
60590	90 mm	
60594	110 mm	
60595	125 mm	
60597	160 mm	
60650	200 mm	

	Winkel 90°	Menge [Stk]
12108	20 mm	
12110	25 mm	
12112	32 mm	
12114	40 mm	
12116	50 mm	
12118	63 mm	
12120	75 mm	
12122	90 mm	
12124	110 mm	
12126	125 mm	
12131	160 mm	
12135	200 mm	

	Muffe	Menge [Stk]
11008	20 mm	
11010	25 mm	
11012	32 mm	
11014	40 mm	
11016	50 mm	
11018	63 mm	
11020	75 mm	
11022	90 mm	
11024	110 mm	
11026	125 mm	

	Red.-Stk.	Menge [Stk]
11112	25/20 mm	
11114	32/20 mm	
11116	32/25 mm	
11118	40/20 mm	
11120	40/25 mm	
11122	40/32 mm	
11124	50/20 mm	
11126	50/25 mm	
11128	50/32 mm	
11130	50/40 mm	
11131	63/20 mm	
11132	63/25 mm	
11134	63/32 mm	
11136	63/40 mm	
11138	63/50 mm	
11143	75/20 mm	
11144	75/25 mm	
11145	75/32 mm	
11139	75/40 mm	
11140	75/50 mm	
11142	75/63 mm	
11151	90/50 mm	
11152	90/63 mm	
11153	90/75 mm	
11155	110/63 mm	
11157	110/75 mm	
11159	110/90 mm	
11161	125/75 mm	
11163	125/90 mm	
11165	125/110 mm	
11177	160/125 mm	
11183	200/125 mm	
11185	200/160 mm	

	Winkel 90° i/a	Menge [Stk]
12308	20 mm	
12310	25 mm	
12312	32 mm	
12314	40 mm	

	Red.-Muffe	Menge [Stk]
11222	40/32 mm	
11228	50/32 mm	
11230	50/40 mm	
11236	63/40 mm	
11238	63/50 mm	
11240	75/50 mm	
11242	75/63 mm	
11252	90/63 mm	
11253	90/75 mm	
11257	110/75 mm	
11259	110/90 mm	
11263	125/90 mm	
11265	125/110 mm	

	Winkel 45°	Menge [Stk]
12508	20 mm	
12510	25 mm	
12512	32 mm	
12514	40 mm	
12516	50 mm	
12518	63 mm	
12520	75 mm	
12522	90 mm	
12524	110 mm	
12526	125 mm	
12531	160 mm	
12535	200 mm	

	Winkel 45° i/a	Menge [Stk]
12708	20 mm	
12710	25 mm	
12712	32 mm	
12714	40 mm	

	T-Stück egal	Menge [Stk]
13108	20 mm	
13110	25 mm	
13112	32 mm	
13114	40 mm	
13116	50 mm	
13118	63 mm	
13120	75 mm	
13122	90 mm	
13124	110 mm	
13126	125 mm	
13131	160 mm	
13135	200 mm	

	Kreuz- stück	Menge [Stk]
13708	20 mm	
13710	25 mm	
13712	32 mm	
13714	40 mm	

	Endkappe	Menge [Stk]
14108	20 mm	
14110	25 mm	
14112	32 mm	
14114	40 mm	
14116	50 mm	
14118	63 mm	
14120	75 mm	
14122	90 mm	
14124	110 mm	
14126	125 mm	
14131	160 mm	
14135	200 mm	

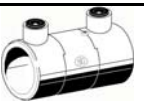
	Elektro- Muffe	Menge [Stk]
17208	20 mm	
17210	25 mm	
17212	32 mm	
17214	40 mm	
17216	50 mm	
17218	63 mm	
17220	75 mm	
17222	90 mm	
17224	110 mm	
17226	125 mm	
17230	160 mm	
17234	200 mm	

	T-Stück reduziert	Menge [Stk]
13511	20x25x20 mm	
13520	25x20x20 mm	
13522	25x20x25 mm	
13532	32x20x20 mm	
13534	32x20x32 mm	
13540	32x25x32 mm	
13542	40x20x40 mm	
13544	40x25x40 mm	
13546	40x32x40 mm	
13547	50x20x50 mm	
13548	50x25x50 mm	
13550	50x32x50 mm	
13551	50x40x50 mm	
13552	63x20x63 mm	
13554	63x25x63 mm	
13556	63x32x63 mm	
13558	63x40x63 mm	
13560	63x50x63 mm	
13561	75x20x75 mm	
13562	75x25x75 mm	
13564	75x32x75 mm	
13566	75x40x75 mm	
13568	75x50x75 mm	
13570	75x63x75 mm	
13576	90x32x90 mm	
13578	90x40x90 mm	
13580	90x50x90 mm	
13582	90x63x90 mm	
13584	90x75x90 mm	
13586	110x63x110 mm	
13588	110x75x110 mm	
13590	110x90x110 mm	
13592	125x75x125 mm	
13594	125x90x125 mm	
13596	125x110x125 mm	
13601	160x75x160 mm	
13603	160x90x160 mm	
13609	200x75x200 mm	
13611	200x90x200 mm	
13613	200x110x200 mm	
13615	200x125x200 mm	

	Kupplungs- Verschraubung	Menge [Stk]
15838	20 mm	
15840	25 mm	
15842	32 mm	
15844	40 mm	
15846	50 mm	
15848	63 mm	
15820	75 mm	

	Einschweiss- Sattel	Menge [Stk]
15156	40/20 mm	
15158	40/25 mm	
15160	50/20 mm	
15162	50/25 mm	
15164	63/20 mm	
15166	63/25 mm	
15168	63/32 mm	
15170	75/20 mm	
15172	75/25 mm	
15174	75/32 mm	
15175	75/40 mm	
15176	90/20 mm	
15178	90/25 mm	
15180	90/32 mm	
15181	90/40 mm	
15182	110/20 mm	
15184	110/25 mm	
15186	110/32 mm	
15188	110/40 mm	
15189	110/50 mm	
15190	125/20 mm	
15192	125/25 mm	
15194	125/32 mm	
15196	125/40 mm	
15197	125/50 mm	
15198	125/63 mm	
15206	160/20 mm	
15208	160/25 mm	
15210	160/32 mm	
15212	160/40 mm	
15214	160/50 mm	
15216	160/63 mm	
15218	160/75 mm	
15220	160/50 mm	
15228	200/20 mm	
15229	200/25 mm	
15230	200/32 mm	
15231	200/40 mm	
15232	200/50 mm	
15233	200/63 mm	
15234	200/75 mm	
15235	200/90 mm	
15236	200/110 mm	
15237	200/125 mm	

	Bundbuchse	Menge [Stk]
15512	32 mm	
15514	40 mm	
15516	50 mm	
15518	63 mm	
15520	75 mm	
15522	90 mm	
15524	110 mm	
15526	125 mm (DN100)	
15527	125 mm	
15531	160 mm	
15533	200 mm	

	Flansch PN 16	Menge [Stk]
15712	32 mm / DN 25	
15714	40 mm / DN 32	
15716	50 mm / DN 40	
15718	63 mm / DN 50	
15720	75 mm / DN 65	
15722	90 mm / DN 80	
15724	110 mm / DN 100	
15726	125 mm / DN 125	
15730	160 mm / DN 150	
15734	200 mm / DN 200	

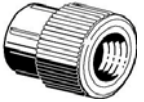
	Übergang Muffe x IG rund	Menge [Stk]
21008	20 x 1/2" IG	
21010	20 x 3/4" IG	
21011	25 x 1/2" IG	
21012	25 x 3/4" IG	
30804	32 x 1/2" IG	
21013	32 x 3/4" IG	

	Übergang Muffe x IG 6-kant	Menge [Stk]
21108	20 x 1/2" IG	
21110	20 x 3/4" IG	
21111	25 x 1/2" IG	
21112	25 x 3/4" IG	
21113	32 x 3/4" IG	
21114	32 x 1" IG	
21115	40 x 1" IG	
21116	40 x 1 1/4" IG	
21117	50 x 1 1/4" IG	
21118	50 x 1 1/2" IG	
21119	63 x 1 1/2" IG	
21120	63 x 2" IG	
21122	75 x 2" IG	

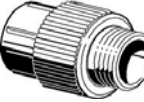
	Übergang Muffe x AG rund	Menge [Stk]
21208	20 x 1/2" AG	
21210	20 x 3/4" AG	
21211	25 x 1/2" AG	
21212	25 x 3/4" AG	
21213	32 x 3/4" AG	

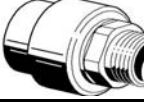
	Übergang Muffe x AG 6-kant	Menge [Stk]
21308	20 x 1/2" AG	
21310	20 x 3/4" AG	
21312	25 x 3/4" AG	
21314	32 x 1" AG	
21316	32 x 1 1/4" AG	
21317	40 x 1" AG	
21318	40 x 1 1/4" AG	
21319	50 x 1 1/4" AG	
21320	50 x 1 1/2" AG	
21321	63 x 1 1/2" AG	
21322	63 x 2" AG	
21323	75 x 2" AG	
21324	75 x 2 1/2" AG	
21325	90 x 3" AG	
21327	110 x 4" AG	

	Übergangswinkel Muffe x IG	Menge [Stk]
23008	20 x 3/4" IG	
23010	20 x 1/2" IG	
23012	25 x 3/4" IG	
23014	25 x 1/2" IG	
23016	32 x 3/4" IG	
23018	32 x 1" IG	

	Übergangswinkel Stutzen x IG	Menge [Stk]
23208	20 x 1/2" IG	

	Übergangswinkel Muffe x AG	Menge [Stk]
23506	20 x 1/2" AG	
23508	20 x 3/4" AG	
23510	25 x 3/4" AG	
23512	32 x 3/4" AG	
23514	32 x 1" AG	

	Übergangswinkel T-Stück M x AG x M	Menge [Stk]
25506	20 x 1/2" AG x 20	

	Übergangswinkel T-Stück M x IG x M	Menge [Stk]
25006	20 x 1/2" IG x 20	
25008	20 x 3/4" IG x 20	
25010	25 x 1/2" IG x 25	
25012	25 x 3/4" IG x 25	
25014	32 x 3/4" IG x 32	
25016	32 x 1" IG x 32	
25022	50 x 1" IG x 50	

	Übergangswinkel Verschraubung Muffe x AG	Menge [Stk]
26608	20 mm AG x 1/2"	
26610	25 mm AG x 3/4"	
26612	32 mm AG x 1"	
26614	40 mm AG x 1 1/4"	
26616	50 mm AG x 1 1/2"	
26618	63 mm AG x 2"	

	Übergangswinkel Verschraubung Muffe x IG	Menge [Stk]
26638	20 mm IG x 1/2"	
26640	25 mm IG x 3/4"	
26642	32 mm IG x 1"	
26644	40 mm IG x 1 1/4"	
26646	50 mm IG x 1 1/2"	
26648	63 mm IG x 2"	

	Übergangswinkel Verschraubung Muffe x Mutter	Menge [Stk]
26808	20 mm x ÜM 3/4"	
26810	25 mm x ÜM 3/4"	
26812	32 mm x ÜM 3/4"	
27010	20 mm x ÜM 1"	
27011	25 mm x ÜM 1"	
27012	25 mm x ÜM 1 1/4"	
27013	32 mm x ÜM 1 1/4"	
27014	32 mm x ÜM 1 1/2"	
27015	40 mm x ÜM 1 1/2"	
27016	40 mm x ÜM 2"	
27017	50 mm x ÜM 2"	
27018	50 mm x ÜM 2 1/4"	
27019	63 mm x ÜM 2 1/4"	
27020	63 mm x ÜM 2 3/4"	
27021	75 mm x ÜM 2 3/4"	
27022	75 mm x ÜM 3 1/2"	

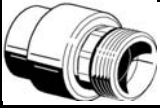
	Einlegeteil zu 270.. MuffexAG	Menge [Stk]
27310	20 mm x AG 1"	
27311	25 mm x AG 1"	
27312	25 mm x AG 1 1/4"	
27313	32 mm x AG 1 1/4"	
27314	32 mm x AG 1 1/2"	
27315	40 mm x AG 1 1/2"	
27316	40 mm x AG 2"	
27317	50 mm x AG 2"	
27318	50 mm x AG 2 1/4"	
27319	63 mm x AG 2 1/4"	
27320	63 mm x AG 2 3/4"	
27321	75 mm x AG 2 3/4"	
27322	75 mm x AG 3 1/2"	

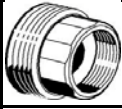
	Einlegeteil zu 270.. AG x IG	Menge [Stk]
27510	1"AG x 1/2"IG	
27512	1 1/4"AG x 3/4"IG	
27514	1 1/2"AG x 1"IG	
27516	2"AG x 1 1/4"IG	
27518	2 1/4"AG x 1 1/2"IG	
27520	2 3/4"AG x 2"IG	
27522	3 1/2"AG x 2 1/2"IG	
27524	4"AG x 3"IG	

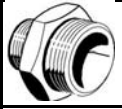
	Einlegeteil zu 270.. AG x AG	Menge [Stk]
27710	1"AG x 1/2"AG	
27712	1 1/4"AG x 3/4"AG	
27714	1 1/2"AG x 1"AG	
27716	2"AG x 1 1/4"AG	
27718	2 1/4"AG x 1 1/2"AG	
27720	2 3/4"AG x 2"AG	
27722	3 1/2"AG x 2 1/2"AG	
27724	4"AG x 3"AG	

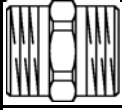
	Doppel- nippel AG x AG	Menge [Stk]
27406	3/8"	
27408	1/2"	
27410	3/4"	
27412	1"	
27414	5/4"	
27416	1 1/2"	
27418	2"	
27420	2 1/2"	

	Überschnitt AG x IG Messing	Menge [Stk]
27436	1/2" x 3/8"	
27438	3/4" x 1/2"	
27440	1" x 3/4"	
27442	5/4" x 1"	
27444	1 1/2" x 5/4"	
27446	2" x 1 1/2"	
27448	2 1/2" x 2"	
27450	3" x 2 1/2"	
27452	4" x 3"	

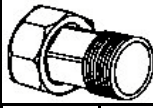
	Ferschraubung AG x IG	Menge [Stk]
27108	3/4" x 1/2"	
27110	1" x 3/4"	
27112	5/4" x 1"	
27114	1 1/2" x 5/4"	
27116	2" x 1 1/2"	
27118	2 1/2" x 2"	
27120	3" x 2 1/2"	

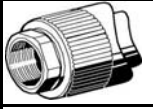
	Einschweiss- Sattel IG	Menge [Stk]
28214	40/25 x 1/2" IG	
28216	50/25 x 1/2" IG	
28218	63/25 x 1/2" IG	
28220	75/25 x 1/2" IG	
28222	90/25 x 1/2" IG	
28224	110/25 x 1/2" IG	
28226	125/25 x 1/2" IG	
28230	160/25 x 1/2" IG	
28232	200/25 x 1/2" IG	
28234	40/25 x 3/4" IG	
28236	50/25 x 3/4" IG	
28238	63/25 x 3/4" IG	
28240	75/25 x 3/4" IG	
28242	90/25 x 3/4" IG	
28244	110/25 x 3/4" IG	
28246	125/25 x 3/4" IG	
28250	160/25 x 3/4" IG	
28254	200/25 x 3/4" IG	
28260	75/30 x 1" IG	
28262	90/32 x 1" IG	
28264	110/32 x 1" IG	
28266	125/32 x 1" IG	
28270	160/32 x 1" IG	
28274	200/32 x 1" IG	

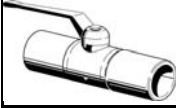
	Kugel- hahn	Menge [Stk]
41308	20 mm	
41310	25 mm	
41312	32 mm	
41314	40 mm	
41316	50 mm	
41318	63 mm	
41320	75 mm	
41322	90 mm	
41324	110 mm	

	Klappen	Menge [Stk]
41326	125 mm	
41330	160 mm	
41334	200 mm	

	Hand- Schweiss- Gerät	Menge [Stk]
50137	für Rohre ø 16 - 63 mm	

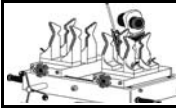
	Fisch Schweiss- Maschine	Menge [Stk]
50137	für Rohre ø - 125 mm	

	Elektro- Muffen- Schweissgerät	Menge [Stk]
50175	für ø 20 - 160 mm	

	Werkstatt Schweiss- Maschine	Menge [Stk]
50163	für Rohre 160 - 315 mm	

	diverses Werkzeug	Menge [Stk]
50104	Rohreschere ø -40 mm	
50105	Rohreschneider ø -125 mm	
50106	Rohreschneider ø - 250 mm	
50939	Bohrer 20mm	
50940	Bohrer 25mm	
50942	Bohrer 32mm	
50944	Bohrer 40mm	
50946	Bohrer 50mm	
50948	Bohrer 63mm	
50190	Temp.-Prüfstift	
50193	Tangit-Tücher	