

Kunde : \_\_\_\_\_

Lieferort : \_\_\_\_\_

Termin : \_\_\_\_\_

Anlage : \_\_\_\_\_

Avis an: \_\_\_\_\_

Projekt-Nr. \_\_\_\_\_

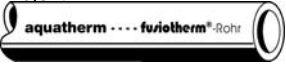
		Menge [m]
<b>Rohr</b>		
4170708	20 x 2.8 mm	
4170710	25 x 3.5 mm	
4170712	32 x 4.4 mm	
4170714	40 x 5.5 mm	
4170716	50 x 6.9 mm	
4170718	63 x 8.6 mm	
4170720	75 x 10.3 mm	
4170722	90 x 12.3 mm	
4170724	110 x 15.1 mm	

4170726 125 x 17.1 mm

		Menge [Stk]
<b>Muffe</b>		
4111008	20 mm	
4111010	25 mm	
4111012	32 mm	
4111014	40 mm	
4111016	50 mm	
4111018	63 mm	
4111020	75 mm	
4111022	90 mm	
4111024	110 mm	

4111026 125 mm

		Menge [Stk]
<b>Red.-Muffe</b>		
4111238	63/50 mm	
4111242	75/63 mm	

4111253 90/75 mm

		Menge [Stk]
<b>Winkel 90°</b>		
4112108	20 mm	
4112110	25 mm	
4112112	32 mm	
4112114	40 mm	
4112116	50 mm	
4112118	63 mm	
4112120	75 mm	
4112122	90 mm	
4112124	110 mm	

4112126 125 mm

		Menge [Stk]
<b>Red.-Stk.</b>		
4111112	25/20 mm	
4111116	32/25 mm	
4111122	40/32 mm	
4111124	50/20 mm	
4111128	50/32 mm	
4111130	50/40 mm	
4111131	63/20 mm	
4111138	63/50 mm	
4111140	75/50 mm	
4111142	75/63 mm	
4111152	90/63 mm	
4111153	90/75 mm	
4111155	110/63 mm	
4111159	110/90 mm	
4111163	125/90 mm	

4111165 125/110 mm

		Menge [Stk]
<b>T-Stück reduziert</b>		
4113511	20x25x20 mm	
4113520	25x20x20 mm	
4113522	25x20x25 mm	
4113532	32x20x20 mm	
4113534	32x20x32 mm	
4113540	32x25x32 mm	
4113544	40x25x40 mm	
4113546	40x32x40 mm	
4113550	50x32x50 mm	
4113551	50x40x50 mm	
4113556	63x32x63 mm	
4113558	63x40x63 mm	
4113560	63x50x63 mm	
4113566	75x40x75 mm	
4113568	75x50x75 mm	
4113570	75x63x75 mm	
4113578	90x40x90 mm	
4113580	90x50x90 mm	
4113582	90x63x90 mm	
4113584	90x75x90 mm	
4113586	110x63x110 mm	
4113588	110x75x110 mm	
4113590	110x90x110 mm	
4113592	125x75x125 mm	
4113594	125x90x125 mm	

4113596 125x110x125 mm

		Menge [Stk]
<b>Winkel 90°</b>		
<b>i/a</b>		
4112308	20 mm	
4112310	25 mm	
4112312	32 mm	

4112314 40 mm

		Menge [Stk]
<b>Winkel 45°</b>		
4112508	20 mm	
4112510	25 mm	
4112512	32 mm	
4112514	40 mm	
4112516	50 mm	
4112518	63 mm	
4112520	75 mm	
4112522	90 mm	
4112524	110 mm	

4112526 125 mm

		Menge [Stk]
<b>Winkel 45°</b>		
<b>i/a</b>		
4112708	20 mm	
4112710	25 mm	
4112712	32 mm	

4112714 40 mm

		Menge [Stk]
<b>T-Stück egal</b>		
4113108	20 mm	
4113110	25 mm	
4113112	32 mm	
4113114	40 mm	
4113116	50 mm	
4113118	63 mm	
4113120	75 mm	
4113122	90 mm	
4113124	110 mm	

4113126 125 mm

		Menge [Stk]
<b>Kreuzstück</b>		
4113712	32 mm	

4113714 40 mm

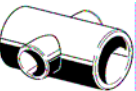
	<b>Kreuz-Stück reduziert</b>	Menge [Stk]
4113750	50/32 mm	
4113756	63/32 mm	
4113758	63/40 mm	
4113764	75/32 mm	
4113766	75/40 mm	
4113776	90/50 mm	

	<b>Endkappe</b>	Menge [Stk]
4114108	20 mm	
4114110	25 mm	
4114112	32 mm	
4114114	40 mm	
4114116	50 mm	
4114118	63 mm	
4114120	75 mm	
4114122	90 mm	
4114124	110 mm	
4114126	125 mm	

	<b>Bund-buchse</b>	Menge [Stk]
4115512	32 mm	
4115514	40 mm	
4115516	50 mm	
4115518	63 mm	
4115520	75 mm	
4115522	90 mm	
4115524	110 mm	
4115527	125 mm	

	<b>Flansch PN 16</b>	Menge [Stk]
4115712	32 mm / DN 25	
4115714	40 mm / DN 32	
4115716	50 mm / DN 40	
4115718	63 mm / DN 50	
4115720	75 mm / DN 65	
4115722	90 mm / DN 80	
4115724	110 mm / DN 100	
4115726	125 mm / DN 125	

	<b>Kupplungs-Verschraubung</b>	Menge [Stk]
4115812	32 mm	
4115814	40 mm	
4115816	50 mm	
4115818	63 mm	
4115820	75 mm	

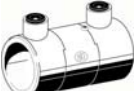
	<b>Elektro-Muffe</b>	Menge [Stk]
17208	20 mm	
17210	25 mm	
17212	32 mm	
17214	40 mm	
17216	50 mm	
17218	63 mm	
17220	75 mm	
17222	90 mm	
17224	110 mm	
17226	125 mm	

	<b>Wand-Scheibe</b>	Menge [Stk]
4.1E+07	20 x 1/2" IG	
4120112	25 x 3/4" IG	

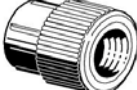
	<b>Übergang Muffe x IG rund</b>	Menge [Stk]
4121008	20 x 1/2" IG	
4121011	25 x 1/2" IG	
4121012	25 x 3/4" IG	
4121013	32 x 3/4" IG	
4121014	32 x 1/2" IG	
4121016	40 x 1/2" IG	
4121017	40 x 3/4" IG	

	<b>Übergang Muffe x IG 6-kant</b>	Menge [Stk]
4121108	20 x 1/2" IG	
4121110	20 x 3/4" IG	
4121111	25 x 1/2" IG	
4121112	25 x 3/4" IG	
4121113	32 x 3/4" IG	
4121114*	32 x 1" IG	
4121115*	40 x 1" IG	
4121116	40 x 5/4" IG	
4121117	50 x 5/4" IG	
4121118	50 x 1 1/2" IG	
4121119	63 x 1 1/2" IG	
4121120	63 x 2" IG	
4121122	75 x 2" IG	
4121153	32 x 1/2" IG	
4121154	40 x 1/2" IG	

\* für den Anschluss an Sprinklerdose geeignet

	<b>Einschweis-Sattel</b>	Menge [Stk]
4115156	40/20 mm	
4115158	40/25 mm	
4115160	50/20 mm	
4115162	50/25 mm	
4115164	63/20 mm	
4115166	63/25 mm	
4115168	63/32 mm	
4115170	75/20 mm	
4115172	75/25 mm	
4115174	75/32 mm	
4115175	75/40 mm	
4115176	90/20 mm	
4115178	90/25 mm	
4115180	90/32 mm	
4115181	90/40 mm	
4115182	110/20 mm	
4115184	110/25 mm	
4115186	110/32 mm	
4115188	110/40 mm	
4115189	110/50 mm	
4115190	125/20 mm	
4115192	125/25 mm	
4115194	125/32 mm	
4115196	125/40 mm	
4115197	125/50 mm	
4115198	125/63 mm	

	<b>Übergang Muffe x AG 6-kant</b>	Menge [Stk]
4121308	20 x 1/2" AG	
4121310	20 x 3/4" AG	
4121311	25 x 1/2" AG	
4121312	25 x 3/4" AG	
4121313	32 x 3/4" AG	
4121314	32 x 1" AG	
4121316	32 x 5/4" AG	
4121317	40 x 1" AG	
4121318	40 x 5/4" AG	
4121319	50 x 5/4" AG	
4121320	50 x 1 1/2" AG	
4121321	63 x 1 1/2" AG	
4121322	63 x 2" AG	
4121323	75 x 2" AG	
4121324	75 x 2 1/2" AG	
4121325	90 x 3" AG	
4121327	110 x 4" AG	

 Übergangs- winkel Muffe x IG	Menge [Stk]
4123008	20 x 3/4" IG
4123010	20 x 1/2" IG
4123012	25 x 3/4"IG
4123014	25 x 1/2" IG
4123015	32 x 1/2" IG
4123016	32 x 3/4" IG
4123018	32 x 1" IG
4123020	40 x 1/2" IG
4123022	40 x 1" IG

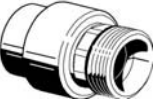
 Einlegeteil zu 270.. MuffexAG	Menge [Stk]
4127310	20 x 1" AG
4127312	25 x 5/4" AG
4127314	32 x 1 1/2" AG
4127316	40 x 2" AG
4127318	50 x 2 1/4" AG
4127320	63 x 2 3/4" AG
4127322	75 x 3 1/2" AG

 Übergangs- Verschr'bung MuffexMutter	Menge [Stk]
4127010	20 x ÜM 1"
4127012	25 x ÜM 5/4"
4127014	32 x ÜM 1 1/2"
4127016	40 x ÜM 2"
4127018	50 x ÜM 2 1/4"
4127020	63 x ÜM 2 3/4"
4127022	75 x ÜM 3 1/2"

 Übergangs- T-Stück M x IG x M	Menge [Stk]
4125006	20 x 1/2" IG x 20
4125008	20 x 3/4" IG x 20
4125010	25 x 1/2" IG x 25
4125012	25 x 3/4" IG x 25
4125013	32 x 1/2" IG x 32
4125014	32 x 3/4" IG x 32
4125016	32 x 1" IG x 32
4125018	40 x 1/2" IG x 40
4125020	40 x 1" IG x 40
4125022	50 x 1" IG x 50
4125024	50 x 5/4"IG x 50

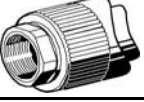
 Einschweiss- Sattel IG	Menge [Stk]
4128214	40/25 x 1/2" IG
4128216	50/25 x 1/2" IG
4128218	63/25 x 1/2" IG
4128220	75/25 x 1/2" IG
4128222	90/25 x 1/2" IG
4128224	110/25 x 1/2" IG
4128226	125/25 x 1/2" IG
4128234	40/25 x 3/4" IG
4128236	50/25 x 3/4" IG
4128238	63/25 x 3/4" IG
4128240	75/25 x 3/4" IG
4128242	90/25 x 3/4" IG
4128244	110/25 x 3/4" IG
4128246	125/25 x 3/4" IG
4128260*	75/32 x 1" IG
4128262*	90/32 x 1" IG
4128264*	110/32 x 1" IG
4128266*	125/32 x 1" IG

 Überschnitt AG x IG Messing	Menge [Stk]
27436	1/2" x 3/8"
27438	3/4" x 1/2"
27440	1" x 3/4"
27442	5/4" x 1"
27444	11/2" x 5/4"
27446	2" x 1 1/2"
27448	2 1/2" x 2"
27450	3" x 2 1/2"
27452	4" x 3"

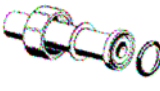
 Anschluss- Verschrau- bung	Menge [Stk]
4126708	20xÜ-Mutter1"
4126710	25xÜ-Mutter5/4"
4126712	32xÜ-Mutter11/2"
4126714	40xÜ-Mutter2"
4126716	50xÜ-Mutter21/4"
4126717	50xÜ-Mutter21/2"
4126718	63xÜ-Mutter23/4"
4126720	75xÜ-Mutter31/2"
4126722	90xÜ-Mutter4"

\* für Anschluss Sprinklerdose geeignet  
benötigt Bohrer und Sattelwerkzeug

 Nutanschluss- Übergang	Menge [Stk]
4127054	40mmx1"Nute
4127056	50mmx5/4"Nute
4127058	63mmx11/2"Nute
4127060	75mmx2"Nute
4127062	90mmx3"Nute
4127064	110mmx4"Nute
4127066	125mmx5"Nute

 Einlegeteil zu 270.. AG x IG	Menge [Stk]
27510	1"AGx1/2"IG
27512	11/4"AGx3/4"IG
27514	11/2"AGx1"IG
27516	2"AGx11/4"IG
27518	21/4"AGx11/2"IG
27520	23/4"AGx2"IG
27522	31/2"AGx21/2"IG
27524	4"AGx3"IG

 Einlegeteil zu 270.. AG x AG	Menge [Stk]
27710	1"AGx1/2"AG
27712	11/4"AGx3/4"AG
27714	11/2"AGx1"AG
27716	2"AGx11/4"AG
27718	21/4"AGx11/2"AG
27720	23/4"AGx2"AG
27722	31/2"AGx21/2"AG
27724	4"AGx3"AG

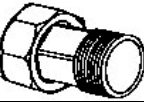
 Verschraubung AG x IG	Menge [Stk]
27108	3/4" x 1/2"
27110	1" x 3/4"
27112	5/4" x 1"
27114	11/2" x 5/4"
27116	2" x 1 1/2"
27118	2 1/2" x 2"
27120	3" x 2 1/2"

 Kugel- hahn	Menge [Stk]
4141308	20 mm
4141310	25 mm
4141312	32 mm
4141314	40 mm
4141316	50 mm
4141318	63 mm

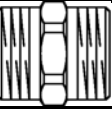
 Doppel- nippel AG x AG	Menge [Stk]
27406	3/8"
27408	1/2"
27410	3/4"
27412	1"
27414	5/4"
27416	1 1/2"
27418	2"
27420	2 1/2"

	Oberteil Sprinkler- dose	Menge [Stk]
4114181	1/2"	
4114182	3/4"	
4114183	1"	
4114191*	1/2"	
4114192*	3/4"	
4114193*	1"	

\* für verdeckte Sprinkler

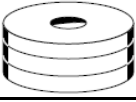
	Putzronde aus PE-Schaum	Menge [Stk]
4114178		

	Stopfen Sprinkler- dose	Menge [Stk]
4114185	1/2"	
4114186	3/4"	
4114187	1"	

	Unterteil Sprinkler- dose	Menge [Stk]
4114180	sichtbare Sprinkler	
4114190	verdeckte Sprinkler	

	Anschluss- dose	Menge [Stk]
4114185	Anschl'dose 5/4"	
4114186	Anschl'dose 1 1/2"	
4114187	Anschl'dose 2"	

	Stopfen Anschluss- dose	Menge [Stk]
4114206	Anschl'dose 5/4"	
4114207	Anschl'dose 1 1/2"	
4114208	Anschl'dose 2"	

	Abdrückstopfen Sprinkler- dose	Menge [Stk]
4114212	Sprinklerdose 1/2"	
4114213	Sprinklerdose 3/4"	
4114214	Sprinklerdose 1"	

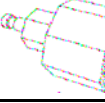
	Kupplungs stecker 1/2"	Menge [Stk]
4114220	1/2" für Art.-Nr. 4114212, -13, -14	

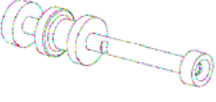
	Kombiausziehwerkzeug	Menge [Stk]
50290	f. Spr'Dose	

	Not- Reparatur Set	Menge [Stk]
60608	für Loch < 8mm	
60610	für Loch < 10mm	
60612	für Loch < 12mm	

	Hand- Schweiss- Gerät	Menge [Stk]
50137	für ø16-63 mm	

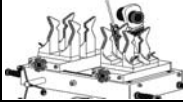
	Fisch Schweiss- maschine	Menge [Stk]
50137	für ø 40-125 mm	

	Elektro- Muffen- Schweissgerät	Menge [Stk]
50175	für ø 20 - 160 mm	

	diverses Werkzeug	Menge [Stk]
50104	R'schere ø -40mm	
50105	R'schneider ø -125mm	
50106	R'schneider ø -250mm	
50939	Bohrer 20mm	
50940	Bohrer 25mm	
50942	Bohrer 32mm	
50944	Bohrer 40mm	
50946	Bohrer 50mm	
50948	Bohrer 63mm	
50190	Temp.-Prüfstift	
50193	Tangit-Tücher	

	Reparatur Set	Menge [Stk]
50307	7mm	
50311	11mm	

	Loch- Stopfen	Menge [Stk]
60600	7/11mm	

Bemerkungen:

---



---



---



---



---



---



---



---